

DES1721G15X65

Sector Panel Antenna

1710–2170MHz | X-Pol | 65° | 15dBi

Electrical Downtilt 0°–12°, Set by Hand or RCU(remote Control Unit)

Electrical specifications			
Model	DES1721G15X65		
Frequency	1710-1880MHz	1850-1990MHz	1900-2170MHz
Polarization	± 45 °		
Horizontal Beamwidth	68 °	66 °	64 °
Vertical Beamwidth	15 °	14 °	13.5 °
Gain	14dBi	14.5dBi	15dBi
RCU Interface	AISG Version 2.0		
RCU Technology Type	External RCU		
Electrical Downtilt	0 ~ 12 °		
VSWR	< 1.5		
Impedance	50 Ω		
Upper SidelobeSuppressions	0°...6°...12° 15dB...15dB...14dB		
Cross-polar ratio	≥15dB (0 °)		
	≥10dB (± 60 °)		
Front to Back Ratio	>25dB		
Isolation Between Ports	> 30dB		
Passive IM3 (2x20w Carrier)	<-150dBc		
Power Rating	300W		
Lightning Protection	Direct Ground		
Mechanical Specifications			
Dimensions(l,w,d)	750 x 150 x 80mm		
Weight with mount	9 kg		
Connector Type	2 x 7/16 DIN-Female		
Radome Material	UV PVC		
Mechanical Downtilt	0 ~ 15°		
Reflector Material	Aluminum Alloy		
IP Grade	IP55		
Operating Temperature	-40°C ~+65°C		
Storage Temperature	-55°C ~+75°C		
Humidity	95%RH@+30		
Max Wind Velocity	200km/hr		

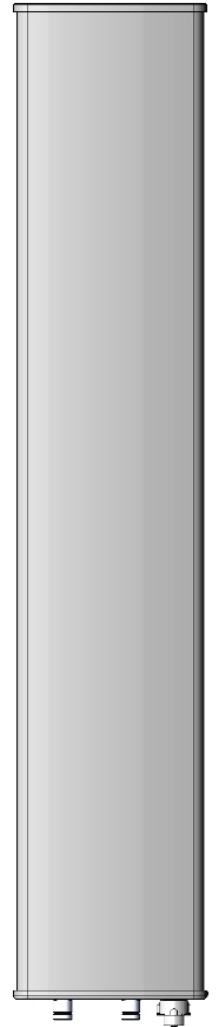

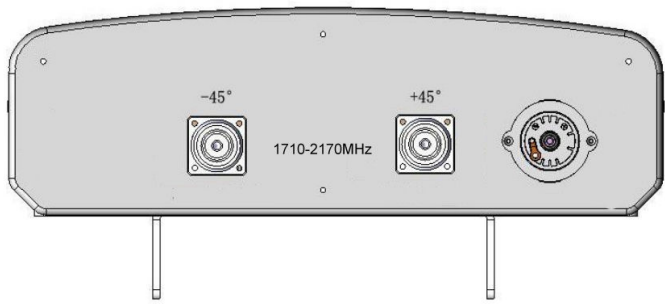

Radio Pattern

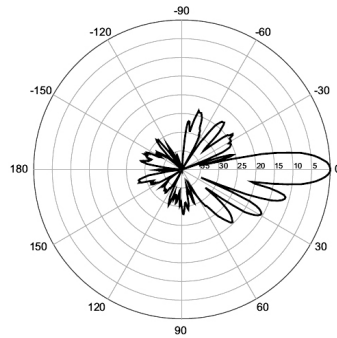
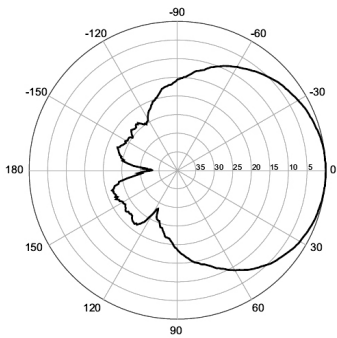

1800MHz Horizontal and Vertical

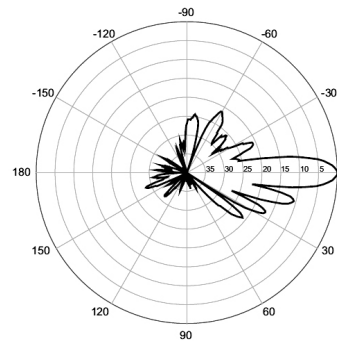
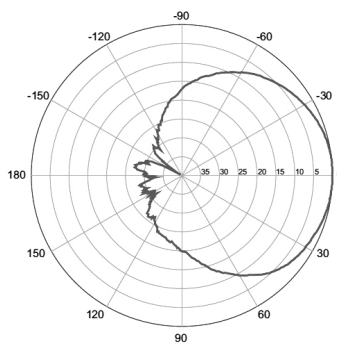

1950MHz Horizontal and Vertical

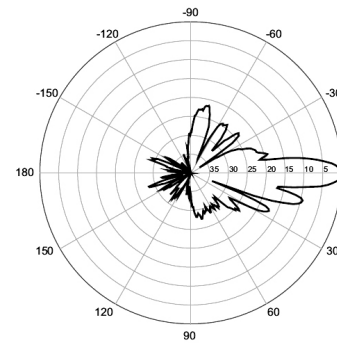
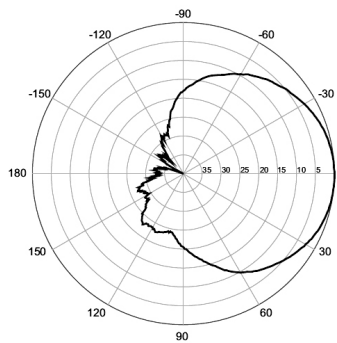

2150MHz Horizontal and Vertical